

1. Features

- n Uses advanced SGT technology
- n Extremely low $R_{DS(on)}$.typ=4.5 mΩ@Vgs=10V
- n Excellent gate charge x $R_{DS(on)}$ product(FOM)

2. Description

- n Motor Drives
- n SR(Synchronous Rectification)
- n DC/DC Converters
- n General purpose applications

3. Pin configuration

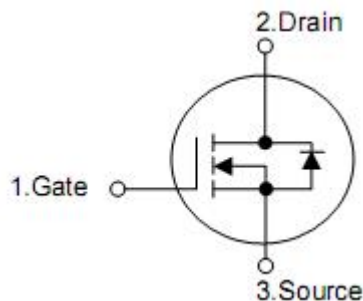
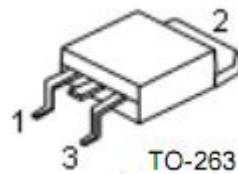

Pin DFN5*6	Pin TO-252、 TO-263	Function
4	1	Gate
5,6,7,8	2	Drain
1,2,3	3	Source

4. Ordering Information

Part Number	Package	Brand
KCB3008A	TO-263	KIA
KCY3008A	DFN5*6	KIA
KCD3008A	TO-252	KIA

5. Absolute maximum ratings

TC=25 °C unless otherwise specified

Parameter	Symbol	Ratings			Unit
		TO-263	DFN5*6	TO-252	
Drain-to-Source Voltage	V_{DSS}	85			V
Continuous Drain Current	I_D	160	100	100	A
	I_D	120	90	80	
	I_D	100	70	60	
Pulsed drain current ($T_C = 25^\circ\text{C}$, t_p limited by T_{jmax})	I_{DP}	480			A
Avalanche energy, single pulse ($L=0.5\text{mH}$, $R_g=25\Omega$)	E_{AS}	560			mJ
Gate-Source voltage	V_{GS}	± 20			V
Power dissipation ($T_C = 25^\circ\text{C}$)	P_{tot}	220	90	85	W
Junction & Storage Temperature Range	T_J & T_{STG}	-55 to 175			$^\circ\text{C}$

6. Thermal characteristics

Parameter	Symbol	Ratings			Units
		TO-263	DFN5*6	TO-252	
Thermal resistance, junction-ambient	$R_{\theta JA}$	60	60	60	$^\circ\text{C/W}$
Thermal resistance, Junction-case	$R_{\theta JC}$	0.68	1.66	1.76	

7. Electrical characteristics

(T_J=25°C, unless otherwise notes)

Parameter	Symbol	Conditions	Min	Typ	Max	Units
Static characteristics						
Drain-source breakdown voltage	BV _{DSS}	V _{GS} =0V, I _D =250μA	85	90	-	V
Zero Gate Voltage Drain Current	I _{DSS}	V _{DS} =85V, V _{GS} =0V, T _J =25°C	-	-	1	μA
		V _{DS} =85V, V _{GS} =0V, T _J =125°C	-	5	-	
Gate threshold voltage	V _{GS(th)}	V _{DS} =V _{GS} , I _D =250μA, T _J =25°C	2.0	3.0	4.0	V
Gate leakage current	I _{GSS}	V _{GS} =20V, V _{DS} =0V	-	-	100	nA
Drain-source on-resistance	R _{DS(on)}	V _{GS} =10V, I _D =50A, T _J =25°C	-	4.5	5.5	mΩ
Transconductance	g _{fs}	V _{DS} =5V, I _D =50A	-	80	-	S
Dynamic characteristics						
Gate Resistance	R _G	V _{GS} =0V, V _{DS} =0V F=1MHz	-	1.5	-	Ω
Input capacitance	C _{iss}	V _{DS} =40V, V _{GS} =0V, F=1MHz	-	4030	-	pF
Output capacitance	C _{oss}		-	545	-	pF
Reverse transfer capacitance	C _{riss}		-	35	-	pF
Turn-on delay time	t _{d(on)}		-	20	-	ns
Rise time	t _r	V _{DS} =40V, T _J =25 °C, V _{GS} =10V, R _L =3Ω	-	38	-	ns
Turn-off delay time	t _{d(off)}		-	45	-	ns
Fall time	t _f		-	20	-	ns
Gate Charge Characteristics						
Total gate charge	Q _g	V _{DS} =40V, I _D =25A, V _{GS} =10V, F=1MHz	-	65	-	nC
Gate-source charge	Q _{gs}		-	25	-	nC
Gate-drain charge	Q _{gd}		-	14	-	nC
Diode characteristics						
Diode forward voltage	V _{SD}	V _{GS} =0V, I _{SD} =50A	-	0.85	1.4	V
Reverse recovery time	t _{rr}	I _F =20A DI _F /dt=500A/μs	-	60	-	ns
Reverse recovery charge	Q _{rr}		-	340	-	nC

8. Typical Characteristics

Figure 1. Typ. Output Characteristics ($T_J=25^\circ\text{C}$)

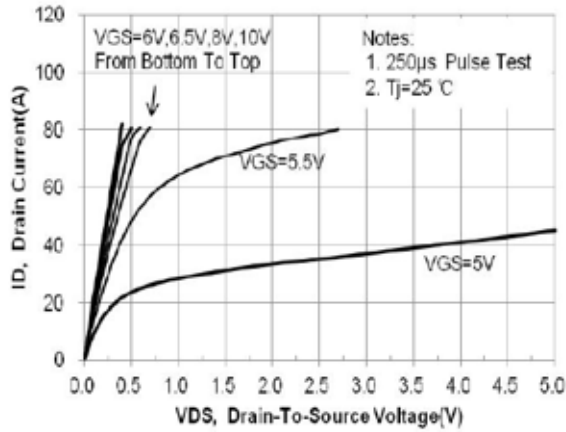

Figure 2. Transfer Characteristics (Junction Temperature)

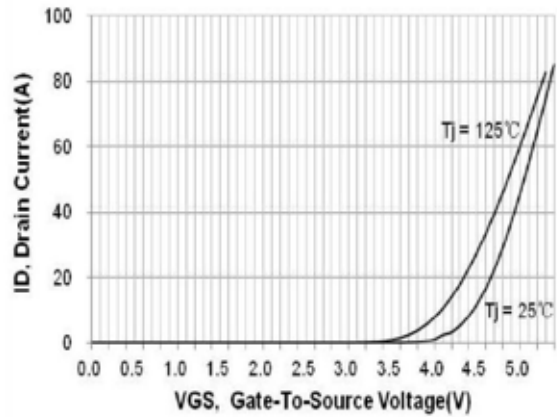

Figure 3. On-Resistance vs. Drain Current and Gate Voltage Figure (TO-252/DFN5*6)

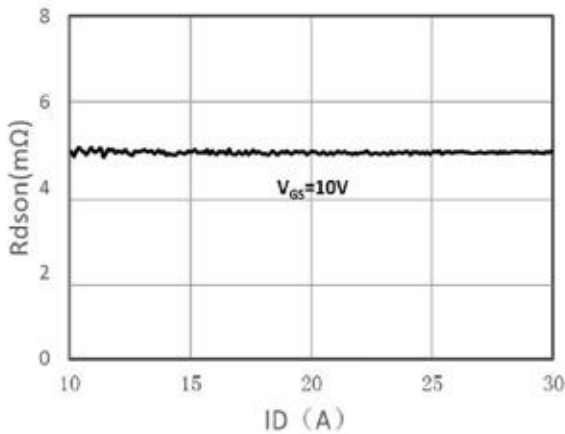

Figure 4. Rds(on) vs Drain Current and Gate Voltage (TO-263)

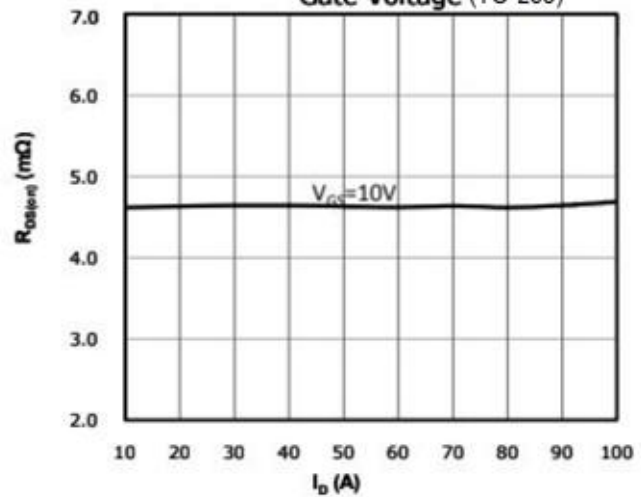

Figure 5. On-Resistance vs. Junction Temperature (TO-252/DFN5*6)

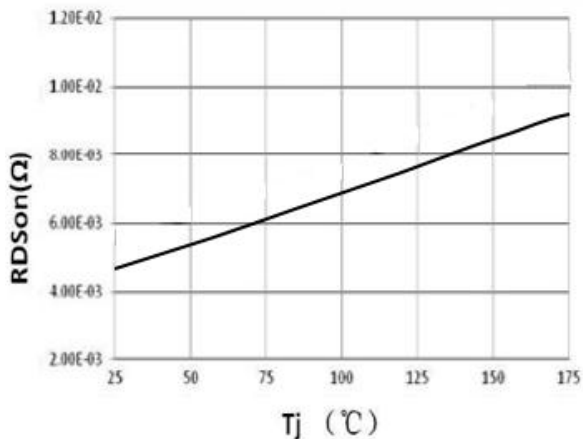

Figure 6. Rds(on) vs. Temperature (TO-263)

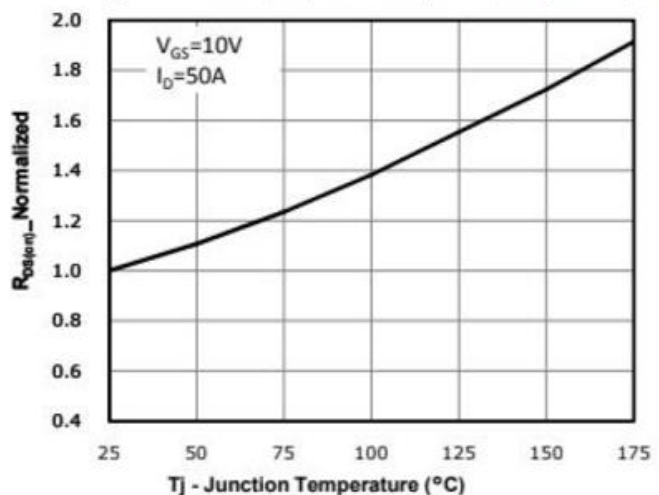

Figure 7. On-Resistance vs. Gate-Source Voltage (Junction Temperature)

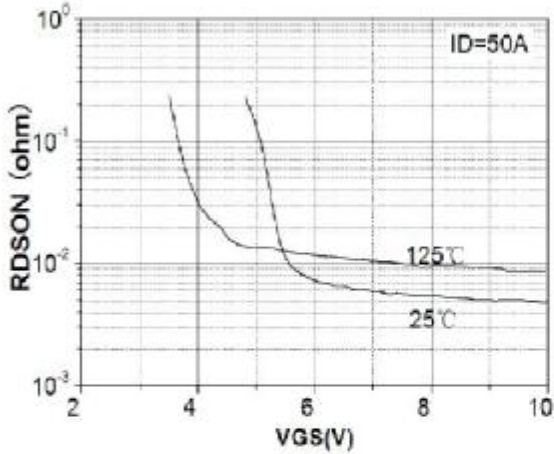

Figure 8. Body-Diode Characteristics (Junction Temperature)

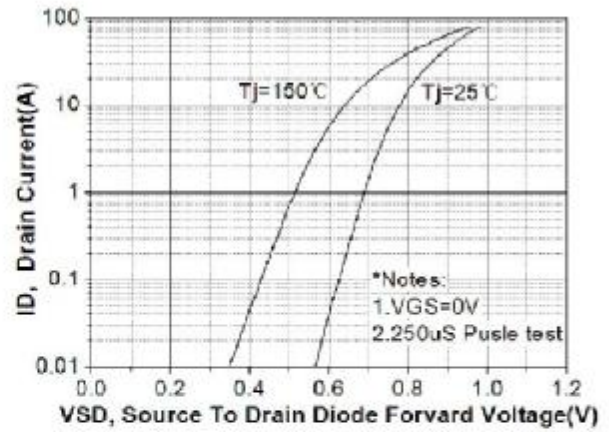

Figure 9. Gate-Charge Characteristics (TO-252/DFN5*6)

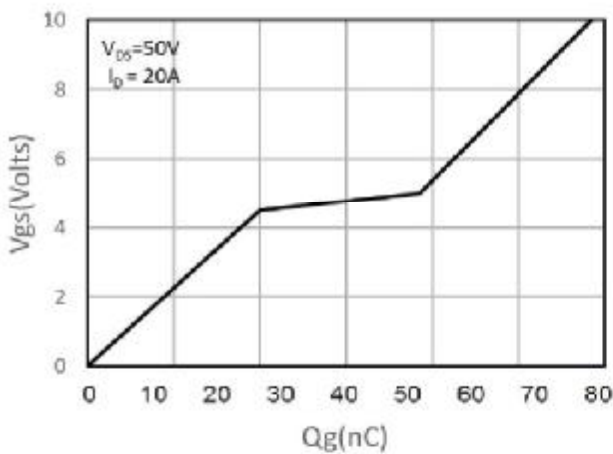

Figure 10. Gate-Charge Characteristics (TO-263)

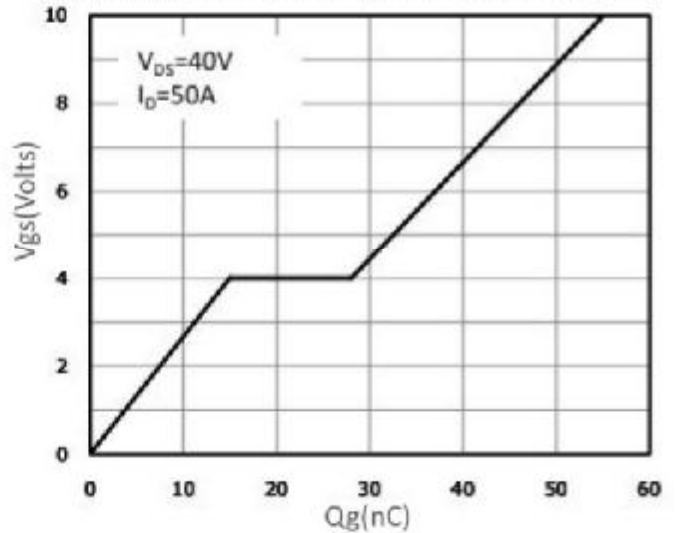

Figure 11. Capacitance Characteristics (TO-263)

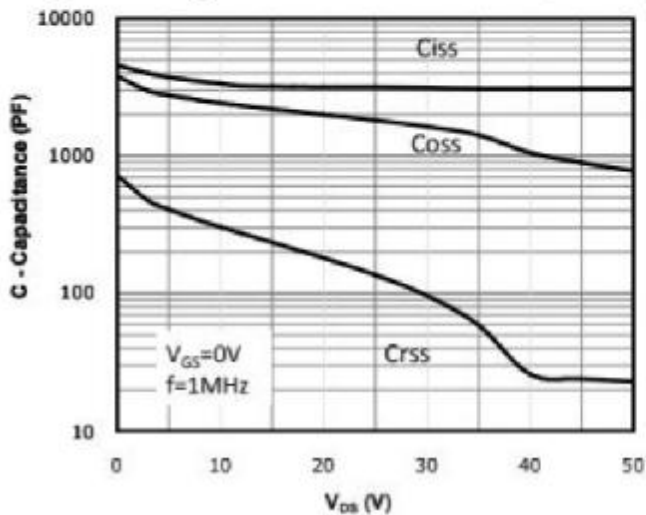

Figure 12. Capacitance Characteristics (TO-252/DFN5*6)

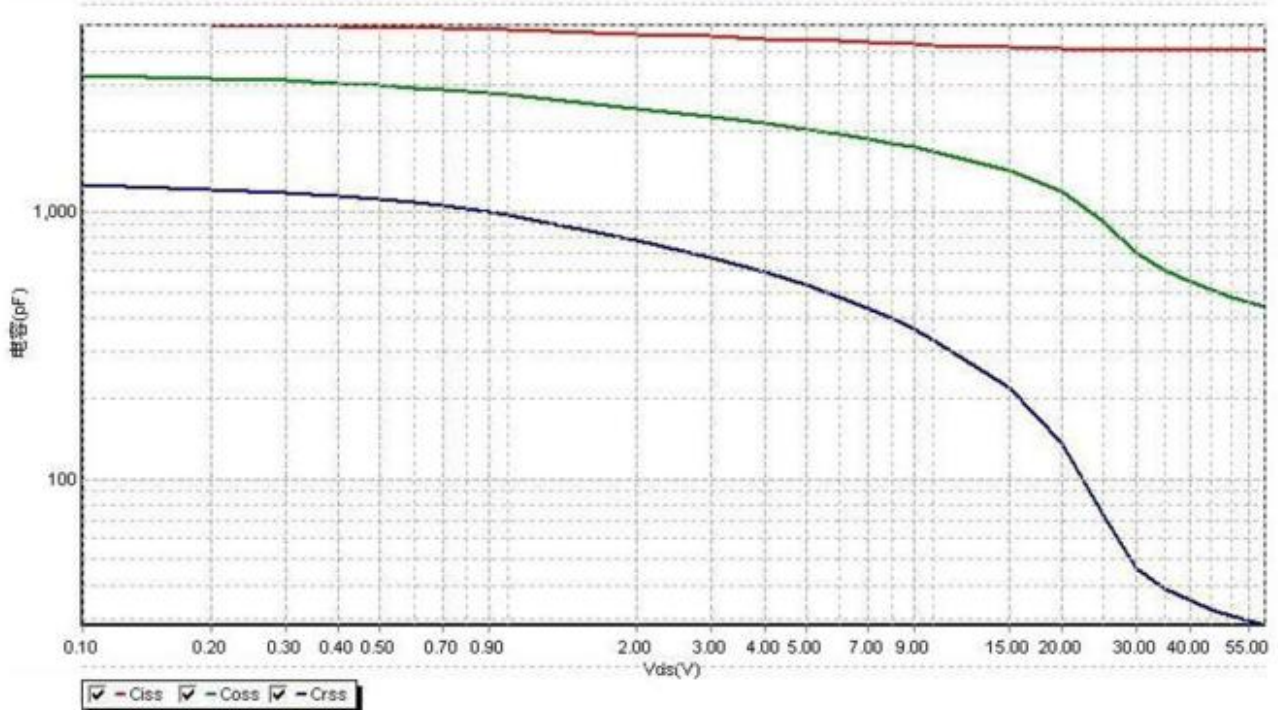

Figure 13. Normalized Maximum Transient Thermal Impedance (R_{thJC})

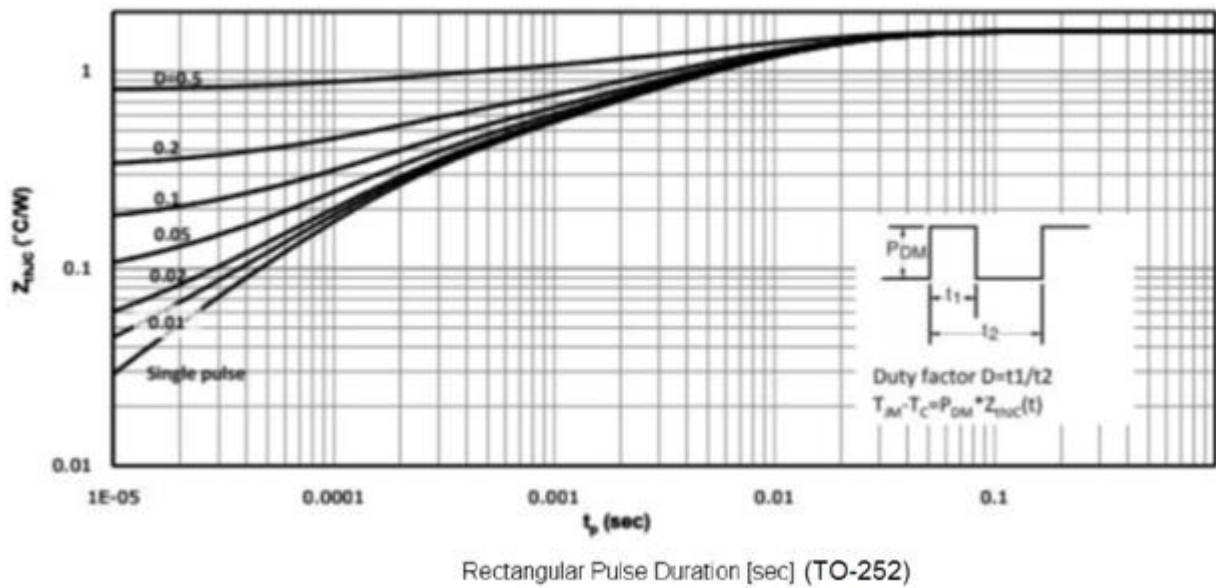

Figure 14. Normalized Maximum Transient Thermal Impedance (R_{thJC})

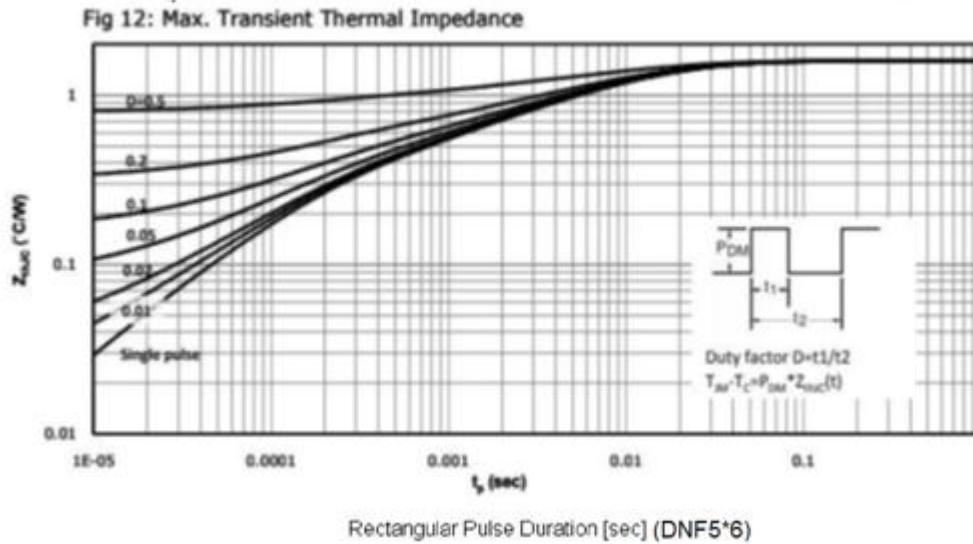
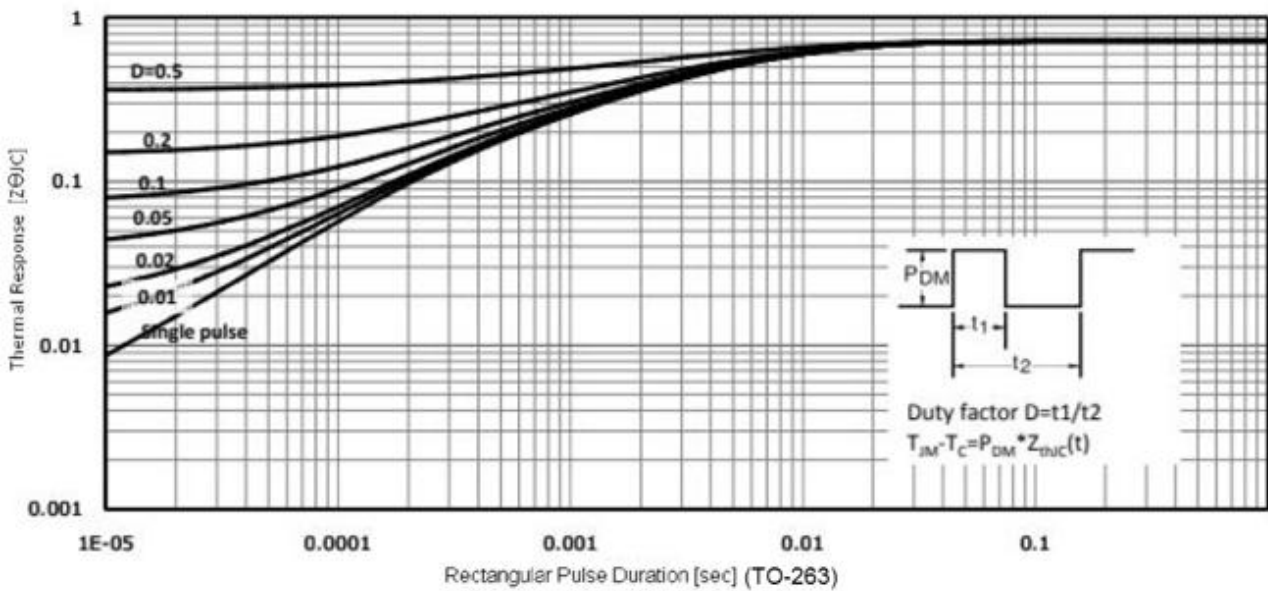
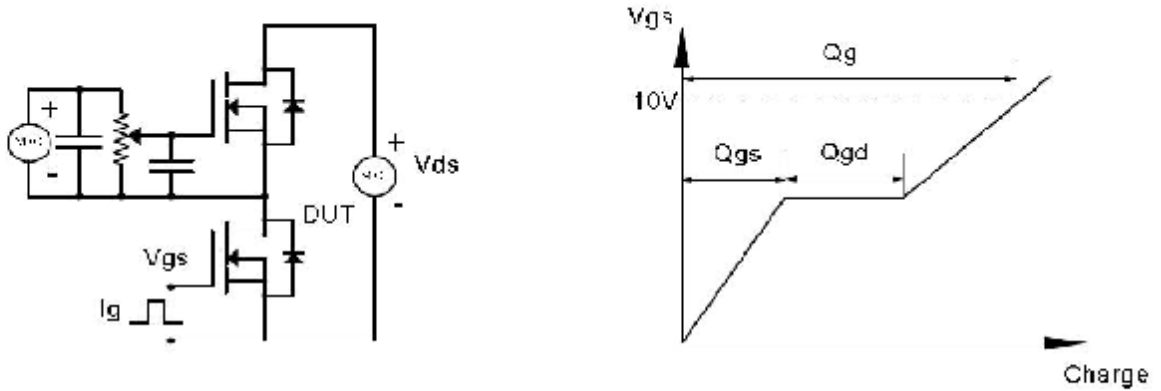

Figure 15. Normalized Maximum Transient Thermal Impedance (R_{thJC})



9. Test Circuit & Waveform

Gate Charge Test: Circuit & Waveform



Resistive Switching Test Circuit & Waveforms

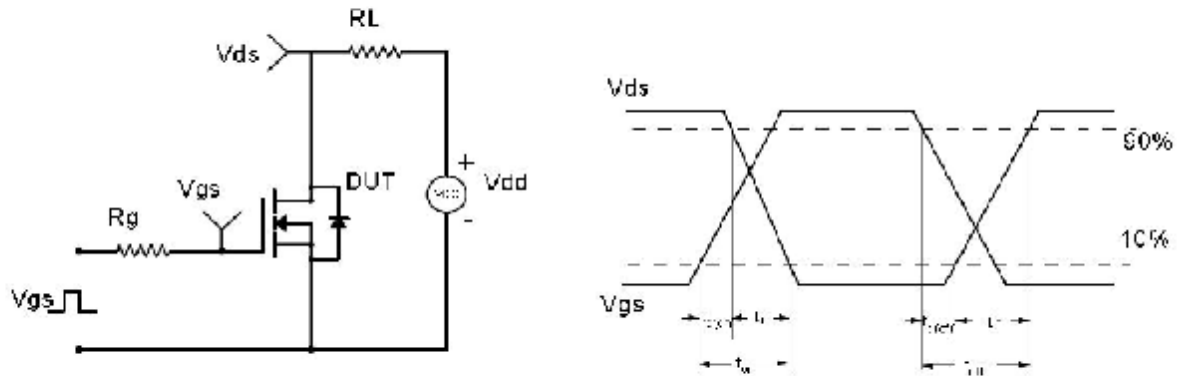

Unclamped Inductive Switching (UIS) Test Circuit & Waveforms

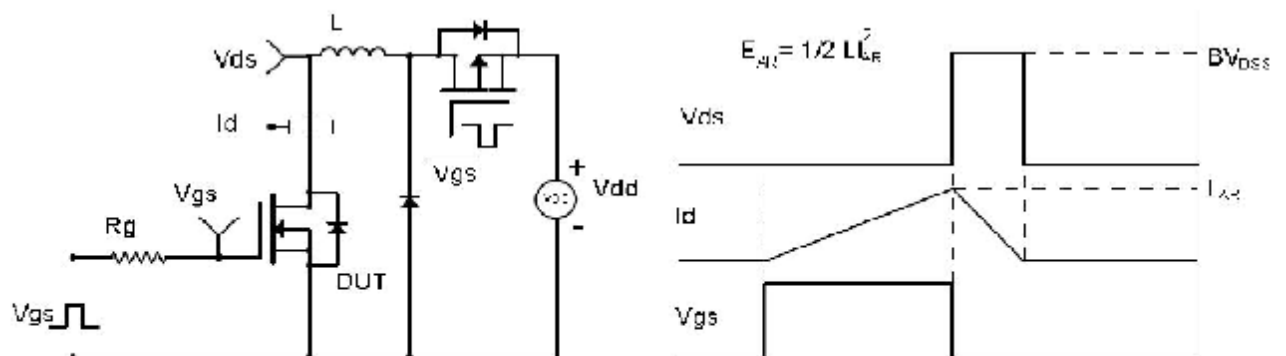

Diode Recovery Test Circuit & Waveforms

